

Lecture 20

More on Waveguides and Transmission Lines

Waveguide is a fundamental component of microwave circuits and systems. The study of closed form solutions offers us physical insight. One can use such insight to design more complex engineering systems. We will use heuristics to understand some systems whose designs follow from physical insight of simpler systems.

Also, we will show that the waveguide problem is homomorphic to the transmission line problem. Here again, many transmission line techniques can be used to solve some complex waveguide problems encountered in microwave and optical engineering by adding junction capacitances and inductances.

20.1 Circular Waveguides, Contd.

As in the rectangular waveguide case, the guidance of the wave in a circular waveguide can be viewed as bouncing waves in the radial direction. But these bouncing waves give rise to standing waves expressible in terms of Bessel functions. The scalar potential (or pilot potential) for the modes in the waveguide is expressible as

$$\Psi_{\alpha s}(\rho, \phi) = AJ_n(\beta_s \rho) e^{\pm jn\phi} \quad (20.1.1)$$

where $\alpha = h$ for TE waves and $\alpha = e$ for TM waves. The Bessel function or wave is expressible in terms of Hankel functions as in (19.2.5). Since Hankel functions are traveling waves, Bessel functions represent standing waves. Therefore, the Bessel waves can be thought of as bouncing traveling waves as in the rectangular waveguide case. In the azimuthal direction, one can express $e^{\pm jn\phi}$ as traveling waves in the ϕ direction, or they can be expressed as $\cos(n\phi)$ and $\sin(n\phi)$ which are standing waves in the ϕ direction.

20.1.1 An Application of Circular Waveguide

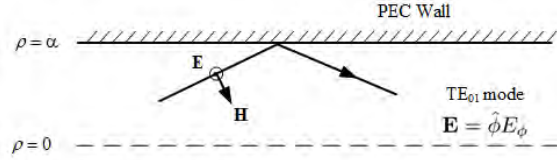

Figure 20.1: Bouncing wave picture of the Bessel wave inside a circular waveguide for the TE_{01} mode.

When a real-world waveguide is made, the wall of the metal waveguide is not made of perfect electric conductor, but with some metal of finite conductivity. Hence, tangential \mathbf{E} field is not zero on the wall implying that $\hat{n} \cdot (\mathbf{E} \times \mathbf{H}^*) \neq 0$. Thus energy can dissipate into the waveguide wall. It turns out that due to symmetry, the TE_{01} mode of a circular waveguide has the lowest loss of all the waveguide modes including rectangular waveguide modes. Hence, this waveguide mode is of interest to astronomers who are interested in building low-loss and low-noise systems.¹

The TE_{01} mode has electric field given by $\mathbf{E} = \hat{\phi} E_\phi$. Furthermore, looking at the magnetic field, the current is mainly circumferential flowing in the ϕ direction. Moreover, by looking at a bouncing wave picture of the guided waveguide mode, this mode has a small component of tangential magnetic field on a waveguide wall: It becomes increasingly smaller as the frequency increases (see Figure 20.1). The reason is that the wave vector for the waveguide becomes increasingly parallel to the axis of the waveguide with a large β_z component compared to the β_s component.² The wave becomes paraxial in the high-frequency limit.

The tangential magnetic field needs to be supported by a surface current on the waveguide wall. This implies that the surface current on the waveguide wall becomes smaller as the frequency increases. The wall loss (or copper loss or eddy current loss) of the waveguide, hence, becomes smaller for higher frequencies. In fact, for high frequencies, the TE_{01} mode has the smallest copper loss of the waveguide modes: It becomes the mode of choice (see Figure 20.2). Waveguides supporting the TE_{01} modes are used to connect the antennas of the very large array (VLA) for detecting extra-terrestrial signals in radio astronomy [120] as shown in Figure 20.3.

¹Low-loss systems are also low-noise due to energy conservation and the fluctuation dissipation theorem [113, 114, 119].

²Recall that for a fixed mode, β_s is independent of frequency.

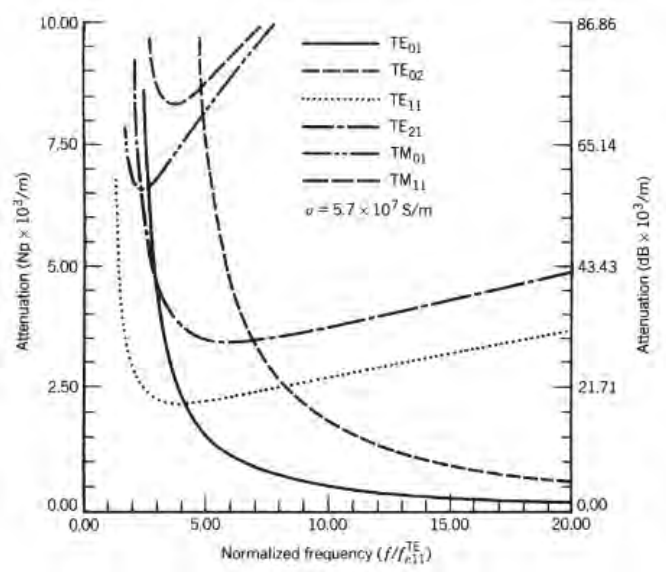

Figure 20.2: Losses of different modes in a circular waveguide of radius 1.5 cm . It is seen that at high frequencies, the TE_{01} mode has the lowest loss (courtesy of [121]).



Figure 20.3: Picture of the Very Large Array in New Mexico, USA (courtesy of [120]).

Figure 20.4 shows two ways of engineering a circular waveguide so that the TE_{01} mode is enhanced: (i) by using a mode filter that discourages the guidance of other modes but not the TE_{01} mode, and (ii), by designing corrugated waveguide wall to discourage the flow of axial current and hence, the propagation of the non- TE_{01} mode. More details of circular waveguides can be found in [121]. Typical loss of a circular waveguide can be as low as 2 dB/km.³

As shall be shown, an open circular waveguide can be made into an aperture antenna quite easily, because the fields of the aperture are axially symmetric. Such antenna is called a horn antenna. Because of this, the radiation pattern of such an antenna is axially symmetric, which can be used to produce axially symmetric circularly polarized (CP) waves. Ways to enhance the TE_{01} mode are also desirable [122] as shown in Figure 20.5.

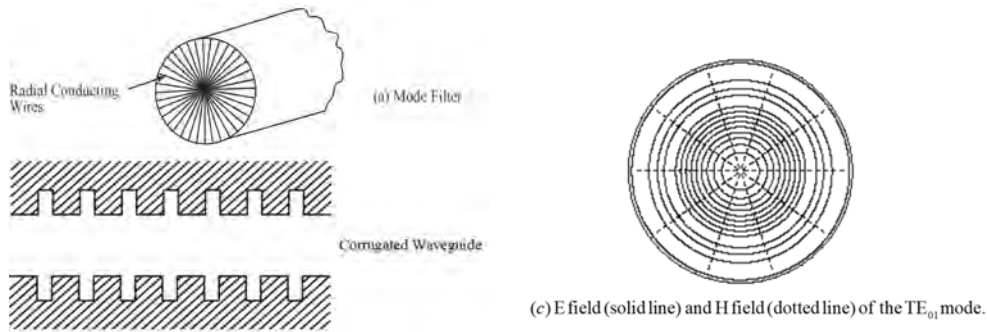

Figure 20.4: Ways to enhance the TE_{01} mode in a circular waveguide: (a) Using mode filter that only allows the mode to go through. (b) Use corrugated waveguide to discourage axial current flow. The field plot of the mode is shown in (c). Such waveguide is used in radio astronomy to design the communication links between antennas in a very large array (VLA [120]), or it is used in a circular horn antenna [122].

³For optical fiber, this figure of merit (FOM) can be lower than 1 dB/km making the optical fiber a darling for long-distance communication.



Figure 20.5: Picture of a circular horn antenna where corrugated wall is used to enhance the TE_{01} mode (courtesy of [123]).

20.2 Remarks on Quasi-TEM Modes, Hybrid Modes, and Surface Plasmonic Modes

We have analyzed some simple structures where closed form solutions are available. These simple elegant solutions offer physical insight into how waves are guided, and how they are cutoff from guidance. As has been shown, for some simple waveguides, the modes can be divided into TEM, TE, and TM modes. However, most waveguides are not simple. We will remark on various complexities that arise in real world applications.

20.2.1 Quasi-TEM Modes

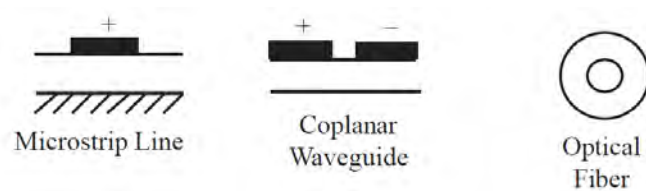

Figure 20.6: Some examples of practical coaxial-like waveguides are microstrip line and coplanar waveguide (left), and the optical fiber (right). The environments of these waveguides are inhomogeneous media, and hence, a pure TEM mode cannot propagate on these waveguides.

Many waveguides cannot support a pure TEM mode even when two conductors are present. For example, two pieces of metal make a transmission line, and in the case of a circular coax, a TEM mode can propagate in the waveguide. But most two-metal transmission lines do not support a pure TEM mode: Instead, they support a quasi-TEM mode. In the optical fiber case, when the index contrast of the fiber is very small, the mode is quasi-TEM as it has to degenerate to the TEM case when the contrast is absent.

Absence of TEM Modes in Inhomogeneously-Filled Waveguides

In the following, we will give physical arguments as to why a pure TEM mode cannot exist in a microstrip line, a coplanar waveguide, and the optical fiber. When a wave is TEM, it is necessary that the wave propagates with the phase velocity of the medium. But when a uniform waveguide has inhomogeneity in between, as shown in Figure 20.6, this is not possible anymore. We can prove this assertion by **reductio ad absurdum**.

Assume only TE wave in a piecewise homogeneous region, then the \mathbf{E} field is

$$\mathbf{E} = \frac{1}{j\omega\varepsilon_i} \nabla \times \nabla \times (\hat{z}\Psi_e) \quad (20.2.1)$$

where ε_i is the permittivity of the region. By doing some algebra, and assume that the field is a waveguide mode such that Ψ_e has $e^{-j\beta_z z}$ dependence, then one can show that E_z is given by

$$E_z = \frac{1}{j\omega\varepsilon_i} (\beta_i^2 - \beta_z^2) \Psi_e \quad (20.2.2)$$

The above derivation is certainly valid in a piecewise homogeneous region. But each of the piecewise homogeneous media can be made arbitrary small, and hence, it is also valid for inhomogeneous media. If this mode becomes TEM, then $E_z = 0$ and this is possible only if $\beta_z = \beta_i$. In other words, the phase velocity of the waveguide mode is the same as a plane TEM wave in the same medium.

Now assume that a TEM wave exists in both inhomogeneous regions of the microstrip line or all three dielectric regions of the optical fiber in Figure 20.6. Then the phase velocities in the z direction, determined by ω/β_z of each region will be ω/β_i of the respective region where β_i is the wavenumber of the i -th region. Hence, phase matching is not possible, and the boundary condition cannot be satisfied at the dielectric interfaces.

Nevertheless, the lumped element circuit model of the transmission line is still a very good model for such a waveguide. If the line capacitance and line inductances of such lines can be estimated, β_z can still be estimated. As shall be shown later, circuit theory is valid when the frequency is low, or the wavelength is large compared to the size of the structures.

20.2.2 Hybrid Modes—Inhomogeneously-Filled Waveguides

For most inhomogeneously filled waveguides, the modes (eigenmodes or eigenfunctions) inside are not cleanly classed into TE and TM modes, but with some modes that are the hybrid of TE and TM modes. If the inhomogeneity is piecewise constant, some of the equations we have derived before are still valid: In other words, in the homogeneous part (or constant part) of the

waveguide filled with piecewise constant inhomogeneity, the fields can still be decomposed into TE and TM fields. But these fields are coupled to each other by the presence of inhomogeneity, i.e., by the boundary conditions requisite at the interface between the piecewise homogeneous regions. Or both TE and TM waves are coupled together and are present simultaneously, and both $E_z \neq 0$ and $H_z \neq 0$. Some examples of inhomogeneously-filled waveguides where hybrid modes exist are shown in Figure 20.7.

Sometimes, the hybrid modes are called EH or HE modes, as in an optical fiber. Nevertheless, the guidance is via a bouncing wave picture, where the bouncing waves are reflected off the boundaries of the waveguides. In the case of an optical fiber or a dielectric waveguide, the reflection is due to total internal reflection. But in the case of metallic waveguides, the reflection is due to the metal walls.

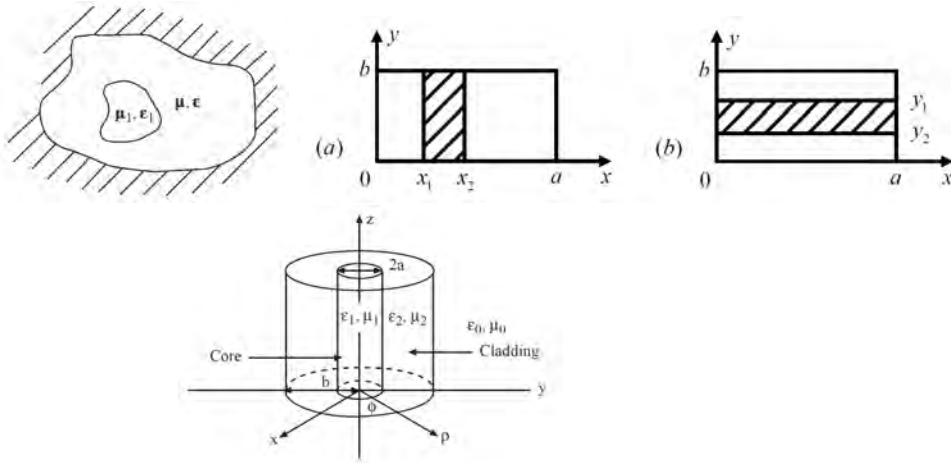

Figure 20.7: Some examples of inhomogeneously filled waveguides where hybrid modes exist: (top-left) A general inhomogeneously filled waveguide, (top-right) slab-loaded rectangular waveguides, and (bottom) an optical fiber with core and cladding.

20.2.3 Guidance of Modes

Propagation of a plane wave in free space is by the exchange of electric stored energy and magnetic stored energy. So the same thing happens in a waveguide. For example, in the transmission line, the guidance is by the exchange of electric and magnetic stored energy via the coupling between the line capacitance and the line inductance of the line. In this case, the waveguide size, like the cross-section of a coaxial cable, can be made much smaller than the wavelength.

In the case of hollow waveguides, the \mathbf{E} and \mathbf{H} fields are coupled through their space and time variations. Namely,

$$\nabla \times \mathbf{E} = -j\omega\mu\mathbf{H}, \quad \nabla \times \mathbf{H} = j\omega\epsilon\mathbf{E} \tag{20.2.3}$$

Hence, the exchange of the energies stored is via the space that stores these energies, like that of a plane wave. These waveguides work only when these plane waves can “enter” the waveguide. Hence, the size of these waveguides has to be about half a wavelength.

The surface plasmonic waveguide is an exception in that the exchange is between the electric field energy stored with the kinetic energy stored in the moving electrons in the plasma instead of magnetic energy stored. This form of energy stored is sometimes referred to as coming from kinetic inductance. Therefore, the dimension of the waveguide can be very small compared to wavelength, and yet the surface plasmonic mode can be guided.

20.3 Homomorphism of Waveguides and Transmission Lines

Previously, we have demonstrated mathematical homomorphism between plane waves in layered medium and transmission lines. Such homomorphism can be further extended to waveguides and transmission lines. But unlike the plane wave in layered medium case, we cannot replace the ∇ operator with $-j\beta$ in a waveguide. Hence, the mathematics is slightly more elaborate. We can show this first for TE modes in a hollow waveguide, and the case for TM modes can be established by invoking duality principle.⁴

20.3.1 TE Case

For this case, $E_z = 0$, and from Maxwell’s equations

$$\nabla \times \mathbf{H} = j\omega\varepsilon\mathbf{E} \quad (20.3.1)$$

By letting $\nabla = \nabla_s + \nabla_z$, $\mathbf{H} = \mathbf{H}_s + \mathbf{H}_z$ where $\nabla_z = \hat{z}\frac{\partial}{\partial z}$, and $\mathbf{H}_z = \hat{z}H_z$, and the subscript s implies transverse to z components, then

$$(\nabla_s + \nabla_z) \times (\mathbf{H}_s + \mathbf{H}_z) = \nabla_s \times \mathbf{H}_s + \nabla_z \times \mathbf{H}_s + \nabla_s \times \mathbf{H}_z \quad (20.3.2)$$

where it is understood that $\nabla_z \times \mathbf{H}_z = 0$. Notice that the first term on the right-hand side of the above is pointing in the z direction. Therefore, by letting $\mathbf{E} = \mathbf{E}_s + \mathbf{E}_z$, and equating transverse components in (20.3.1), we have⁵

$$\nabla_z \times \mathbf{H}_s + \nabla_s \times \mathbf{H}_z = j\omega\varepsilon\mathbf{E}_s \quad (20.3.3)$$

To simplify the above equation, we shall remove \mathbf{H}_z from above. Next, from Faraday’s law, we have

$$\nabla \times \mathbf{E} = -j\omega\mu\mathbf{H} \quad (20.3.4)$$

Again, by letting $\mathbf{E} = \mathbf{E}_s + \mathbf{E}_z$, we can let (20.3.4) be written as

$$\nabla_s \times \mathbf{E}_s + \nabla_z \times \mathbf{E}_s + \nabla_s \times \mathbf{E}_z = -j\omega\mu(\mathbf{H}_s + \mathbf{H}_z) \quad (20.3.5)$$

⁴I have not seen exposition of such mathematical homomorphism elsewhere except in very simple cases [32].

⁵And from the above, it is obvious that $\nabla_s \times \mathbf{H}_s = j\omega\varepsilon\mathbf{E}_z$, but this equation will not be used in the subsequent derivation.

Equating z components of the above, we have

$$\nabla_s \times \mathbf{E}_s = -j\omega\mu\mathbf{H}_z \quad (20.3.6)$$

The above allows us to express \mathbf{H}_z in terms of \mathbf{E}_s . Using (20.3.6), Eq.(20.3.3) can be rewritten as

$$\nabla_z \times \mathbf{H}_s + \nabla_s \times \frac{1}{-j\omega\mu} \nabla_s \times \mathbf{E}_s = +j\omega\varepsilon\mathbf{E}_s \quad (20.3.7)$$

The above can be further simplified by noting that

$$\nabla_s \times \nabla_s \times \mathbf{E}_s = \nabla_s(\nabla_s \cdot \mathbf{E}_s) - \nabla_s \cdot \nabla_s \mathbf{E}_s \quad (20.3.8)$$

But since $\nabla \cdot \mathbf{E} = 0$, and $E_z = 0$ for TE modes, it also implies that $\nabla_s \cdot \mathbf{E}_s = 0$. Also, from Maxwell's equations, we have previously shown that for a homogeneous source-free medium,

$$(\nabla^2 + \beta^2)\mathbf{E} = 0 \quad (20.3.9)$$

with $E_z = 0$ for TE mode, or that

$$(\nabla^2 + \beta^2)\mathbf{E}_s = 0 \quad (20.3.10)$$

Assuming that we have a guided mode, then

$$\mathbf{E}_s \sim e^{\mp j\beta_z z}, \quad \frac{\partial^2}{\partial z^2} \mathbf{E}_s = -\beta_z^2 \mathbf{E}_s \quad (20.3.11)$$

Therefore, (20.3.10) becomes

$$(\nabla_s^2 + \beta^2 - \beta_z^2)\mathbf{E}_s = 0 \quad (20.3.12)$$

or that

$$(\nabla_s^2 + \beta_s^2)\mathbf{E}_s = 0 \quad (20.3.13)$$

where $\beta_s^2 = \beta^2 - \beta_z^2$ is the transverse wave number. Consequently, from (20.3.8)

$$\nabla_s \times \nabla_s \times \mathbf{E}_s = -\nabla_s^2 \mathbf{E}_s = \beta_s^2 \mathbf{E}_s \quad (20.3.14)$$

As such, (20.3.7) becomes

$$\begin{aligned} \nabla_z \times \mathbf{H}_s &= j\omega\varepsilon\mathbf{E}_s + \frac{1}{j\omega\mu} \nabla_s \times \nabla_s \times \mathbf{E}_s \\ &= j\omega\varepsilon\mathbf{E}_s + \frac{1}{j\omega\mu} \beta_s^2 \mathbf{E}_s \\ &= j\omega\varepsilon \left(1 - \frac{\beta_s^2}{\beta^2} \right) = j\omega\varepsilon \frac{\beta_z^2}{\beta^2} \mathbf{E}_s \end{aligned} \quad (20.3.15)$$

Letting $\beta_z = \beta \cos \theta$, then the above can further be rewritten as

$$\nabla_z \times \mathbf{H}_s = j\omega\varepsilon \cos^2 \theta \mathbf{E}_s \quad (20.3.16)$$

The above now resembles one of the two telegrapher's equations that we seek. Now looking at (20.3.4) again, assuming $E_z = 0$, equating transverse components, we have

$$\nabla_z \times \mathbf{E}_s = -j\omega\mu \mathbf{H}_s \quad (20.3.17)$$

More explicitly, we can rewrite (20.3.16) and (20.3.17) in the above as

$$\frac{\partial}{\partial z} \hat{z} \times \mathbf{H}_s = j\omega\varepsilon \cos^2 \theta \mathbf{E}_s \quad (20.3.18)$$

$$\frac{\partial}{\partial z} \hat{z} \times \mathbf{E}_s = -j\omega\mu \mathbf{H}_s \quad (20.3.19)$$

The above now resembles the telegrapher's equations. We can multiply (20.3.19) by $\hat{z} \times$ to get

$$\frac{\partial}{\partial z} \mathbf{E}_s = j\omega\mu \hat{z} \times \mathbf{H}_s \quad (20.3.20)$$

Now (20.3.18) and (20.3.20) are a set of coupled equations that look even more like the telegrapher's equations. We can have $\mathbf{E}_s \rightarrow V$, $\hat{z} \times \mathbf{H}_s \rightarrow -I$. $\mu \rightarrow L$, $\varepsilon \cos^2 \theta \rightarrow C$, and the above resembles the telegrapher's equations, or that the waveguide problem is homomorphic to the transmission line problem. The characteristic impedance of this line is then

$$Z_0 = \sqrt{\frac{L}{C}} = \sqrt{\frac{\mu}{\varepsilon \cos^2 \theta}} = \sqrt{\frac{\mu}{\varepsilon}} \frac{1}{\cos \theta} = \frac{\omega\mu}{\beta_z} \quad (20.3.21)$$

Therefore, the TE modes of a waveguide can be mapped into a transmission problem. This can be done, for instance, for the TE_{mn} mode of a rectangular waveguide. Then, in the above

$$\beta_z = \sqrt{\beta^2 - \left(\frac{m\pi}{a}\right)^2 - \left(\frac{n\pi}{b}\right)^2} \quad (20.3.22)$$

Therefore, each TE_{mn} mode will be represented by a different characteristic impedance Z_0 , since β_z is different for different TE_{mn} modes.

20.3.2 TM Case

This case can be derived using duality principle. Invoking duality, and after some algebra, then the equivalence of (20.3.18) and (20.3.20) become

$$\frac{\partial}{\partial z} \mathbf{E}_s = j\omega\mu \cos^2 \theta \hat{z} \times \mathbf{H}_s \quad (20.3.23)$$

$$\frac{\partial}{\partial z} \hat{z} \times \mathbf{H}_s = j\omega\varepsilon\mathbf{E}_s \tag{20.3.24}$$

To keep the dimensions commensurate, we can let $\mathbf{E}_s \rightarrow V$, $\hat{z} \times \mathbf{H}_s \rightarrow -I$, $\mu \cos^2 \theta \rightarrow L$, $\varepsilon \rightarrow C$, then the above resembles the telegrapher's equations. We can thus let

$$Z_0 = \sqrt{\frac{L}{C}} = \sqrt{\frac{\mu \cos^2 \theta}{\varepsilon}} = \sqrt{\frac{\mu}{\varepsilon} \cos^2 \theta} = \frac{\beta_z}{\omega\varepsilon} \tag{20.3.25}$$

Please note that (20.3.21) and (20.3.25) are very similar to that for the plane wave case, which are the wave impedance for the TE and TM modes, respectively.

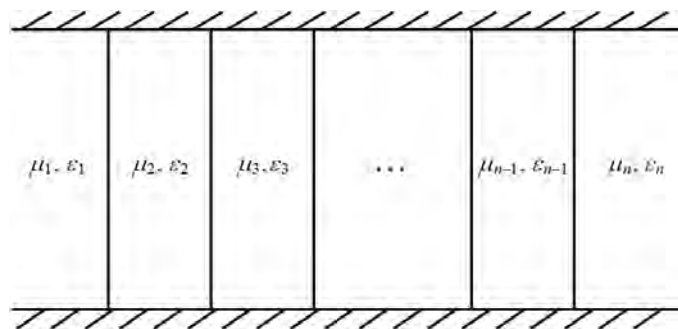

Figure 20.8: A waveguide filled with layered medium is mathematically homomorphic to a multi-section transmission line problem. Hence, transmission-line method can be used to solve this problem, but junction capacitance and inductance are needed to model the junctions correctly.

The above implies that if we have a waveguide of arbitrary cross section filled with layered media, the problem can be mapped to a multi-section transmission line problem, and solved with transmission line methods. When V and I are continuous at a transmission line junction, \mathbf{E}_s and \mathbf{H}_s will also be continuous. Hence, the transmission line solution would also imply continuous \mathbf{E} and \mathbf{H} field solutions.

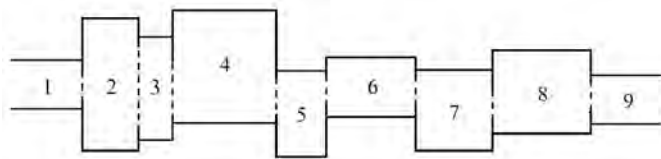

Figure 20.9: A multi-section waveguide is not exactly homomorphic to a multi-section transmission line problem, when the cross section of the waveguides are not equal to each other. Circuit elements are needed at the junctions to capture the physics at the waveguide junctions as shown in the next figure.

20.3.3 Mode Conversion

In the waveguide shown in Figure 20.8, there is no mode conversion at the junction interface. Assuming a rectangular waveguide as an example, what this means is that if we send at TE_{10} into the waveguide, this same mode will propagate throughout the length of the waveguide. The reason is that only this mode alone is sufficient to satisfy the boundary condition at the junction interface. The mode profile does not change throughout the length of the waveguide.

To elaborate further, from our prior knowledge, the transverse fields of the waveguide, e.g., for the TM mode, can be derived to be

$$\mathbf{H}_s = \nabla \times \hat{z} \Psi_{es}(\mathbf{r}_s) e^{\mp j \beta_z z} \quad (20.3.26)$$

$$\mathbf{E}_s = \frac{\mp \beta_z}{\omega \varepsilon} \nabla_s \Psi_{es}(\mathbf{r}_s) e^{\mp j \beta_z z} \quad (20.3.27)$$

In the above, β_s^2 and $\Psi_{es}(\mathbf{r}_s)$ are eigenvalue and eigenfunction, respectively, that depend only on the geometrical shape of the waveguide, but not the materials filling the waveguide. These eigenfunctions are the same throughout different sections of the waveguide. Therefore, boundary conditions can be easily satisfied at the junctions.

However, for a multi-junction waveguide show in Figure 20.9, tangential \mathbf{E} and \mathbf{H} continuous condition cannot be satisfied by a single mode in each waveguide alone: V and I continuous at a transmission line junction will not guarantee the continuity of tangential \mathbf{E} and tangential \mathbf{H} fields at the waveguide junction.

Multi-modes have to be assumed on both sides of the junction at each section in order to match boundary conditions at the junction [83]. Moreover, mode matching method for multiple modes has to be used at each junction. Typically, a single mode incident at a junction will give rise to multiple modes reflected and multiple modes transmitted. The multiple modes give rise to the phenomenon of **mode conversion** at a junction. Hence, the waveguide may need to be modeled with multiple transmission lines where each mode is modeled by a different transmission line with different characteristic impedances.

However, the operating frequency can be chosen so that only one mode is propagating at each section of the waveguide, and the other modes are cutoff or evanescent. In this case, the multiple modes at a junction give rise to localized energy storage at a junction. These energies can be either inductive or capacitive. The junction effect may be modeled by a simple circuit model as shown in Figure 20.10. These junction elements also account for the physics that the currents and voltages are not continuous anymore across the junction. Moreover, these junction lumped circuit elements account for the stored electric and magnetic energies at the junction.

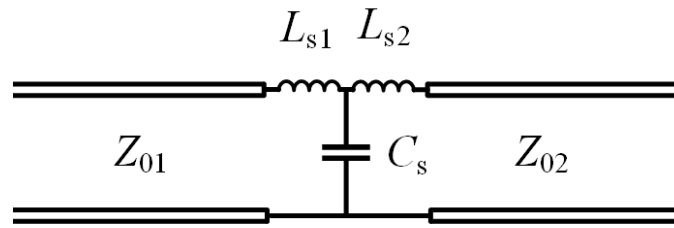

Figure 20.10: Junction circuit elements are used to account for stored electric and magnetic energies at the junction. They also account for that the currents and voltages are not continuous across the junctions anymore as the fields of the dominant modes in each section as shown in Figure 20.9 are not continuous anymore.

